

MARCH 2-3, 2024



**11TH LATVIA OPEN WUSHU
CHAMPIONSHIPS**
TAOLU | BINGDAO | SANDA

+371 24 220 635 | lwuf@lwuf.lv | www.lwuf.lv

*11th LATVIA OPEN WUSHU
CHAMPIONSHIPS*

March 2-3, 2024

Final Results

"Taolu Barehand Changquan B (3 set), C (1,2 set) forms | Male | Cadets, Juniors 12-17 years"

#	<i>Name</i>	<i>Team</i>	<i>Country</i>	<i>Score</i>
1	Nikoloz Nutsbidze	Georgia Wushu Team	Georgia	8.466
2	Saba Edilashvili	Georgia Wushu Team	Georgia	8.433
3	Danila Morevs	Team Konoha Martial Arts Academy	Latvia	7.934
4	Filips Sebastians Banders	Rīgas U-šu Kungfu un austrumcīņu sporta centrs	Latvia	7.867

"Taolu Barehand Changquan A (Nandu), B (3 set) forms | Female | Cadets, Juniors, Adults"

#	<i>Name</i>	<i>Team</i>	<i>Country</i>	<i>Score</i>
1	Estere Sofija Spūle	Rīgas U-šu Kungfu un austrumcīņu sporta centrs	Latvia	8.766
2	Mariam Arziani	Georgia Wushu Team	Georgia	8.717
3	Anastasiya Kokina	Rīgas U-šu Kungfu un austrumcīņu sporta centrs	Latvia	8.45
4	Anastasija Vlasenko	Rīgas U-šu Kungfu un austrumcīņu sporta centrs	Latvia	8.3
5	Sandra Pļenkova	Team Kung Fu PANSIN	Latvia	7.766
6	Anastasija Zorina	Rīgas U-šu Kungfu un austrumcīņu sporta centrs	Latvia	7.633

"Taolu Barehand Taijiquan A (Nandu) forms | Male | Cadets 12-14 years"

#	<i>Name</i>	<i>Team</i>	<i>Country</i>	<i>Score</i>
1	Roberts Ritenbergs	Rīgas U-šu Kungfu un austrumcīņu sporta centrs	Latvia	8.3

"Taolu Barehand Nanquan B (3 set) forms | Male | Juniors 15-17 years"

#	<i>Name</i>	<i>Team</i>	<i>Country</i>	<i>Score</i>
1	Maksims Jevsejevs	Rīgas U-šu Kungfu un austrumcīņu sporta centrs	Latvia	8.9
2	Nykyta Kokins	Rīgas U-šu Kungfu un austrumcīņu sporta centrs	Latvia	8.566

"Taolu Barehand Changquan C (1,2 set) forms | Female | Cadets, Juniors 12-15 years"

#	<i>Name</i>	<i>Team</i>	<i>Country</i>	<i>Score</i>
1	Gvantsa Karchava	Georgia Wushu Team	Georgia	8.533
2	Sofija Hopaniuk	Team Konoha Martial Arts Academy	Latvia	8.033
3	Veronika Veidere	Team Konoha Martial Arts Academy	Latvia	7.817
4	Polina Kovtņuka	Team Konoha Martial Arts Academy	Latvia	7.717

"Taolu Barehand Changquan D (32) forms | Male | Children 9-11 years"

#	<i>Name</i>	<i>Team</i>	<i>Country</i>	<i>Score</i>
1	Davit Lavrelashvili	Georgia Wushu Team	Georgia	7.95
2	Jevhenii Sushkevych	Team Konoha Martial Arts Academy	Latvia	7.684
3	Ilja Kiseļovs	Rīgas U-šu Kungfu un austrumcīņu sporta centrs	Latvia	7.666
4	Mihails Aleksejevs	Team Kung Fu PANSIN	Latvia	7.483
5	Vladislavs Beļskis	Team Konoha Martial Arts Academy	Latvia	7.167
6	Timurs Krasnovs	Team Konoha Martial Arts Academy	Latvia	7.1

"Taolu Barehand Changquan D (32) forms | Female | Children, cadets 9-12 years"

#	Name	Team	Country	Score
1	Mariam Gvelesiani	Georgia Wushu Team	Georgia	8.183
2	Anna Chitorelidze	Georgia Wushu Team	Georgia	8.05
3	Uljana Lukjanenko	Team Konoha Martial Arts Academy	Latvia	7.866
4	Anna Zablocka	Team Konoha Martial Arts Academy	Latvia	7.8
5	Sati Bagojana	Team Konoha Martial Arts Academy	Latvia	7.35
6	Polina Romaševa	Team Konoha Martial Arts Academy	Latvia	7.234
7	Nikoļa Petrova	Rīgas U-šu Kungfu un austrumcīņu sporta centrs	Latvia	7.067
8	Ksenija Romaševa	Team Konoha Martial Arts Academy	Latvia	7.066
9	Marija Kustova	Rīgas U-šu Kungfu un austrumcīņu sporta centrs	Latvia	6.85
10	Samanta Dzenīte	Team Kung Fu PANSIN	Latvia	6.583
11	Anna Naudžuna	Rīgas U-šu Kungfu un austrumcīņu sporta centrs	Latvia	6.433

"Taolu Barehand Changquan E (16,20,24) forms | Male | Children 7-9 years"

#	Name	Team	Country	Score
1	Markuss Makņa	Team Konoha Martial Arts Academy	Latvia	6.917
2	Dmitrijs Dzedzuško	Team Konoha Martial Arts Academy	Latvia	6.766
3	Deniss Horošilovs	Team Konoha Martial Arts Academy	Latvia	6.5
4	Iļja Dubānis	Rīgas U-šu Kungfu un austrumcīņu sporta centrs	Latvia	6.133

"Taolu Short weapons Jianshu B (3 set), C (1,2 set) forms | Female | Cadets 12-14 years"

#	Name	Team	Country	Score
1	Gvantsa Karchava	Georgia Wushu Team	Georgia	8.834
2	Zlata Tvorogova	Team Konoha Martial Arts Academy	Latvia	8.45
3	Anastasija Zorina	Rīgas U-šu Kungfu un austrumcīņu sporta centrs	Latvia	7.467

"Taolu Short weapons Jianshu, Daoshu B (3 set), C (1,2 set) forms | Male | Cadets, Juniors"

#	Name	Team	Country	Score
1	Saba Edilashvili	Georgia Wushu Team	Georgia	8.817
2	Nikolozis Nutsbidze	Georgia Wushu Team	Georgia	8.75
3	Filips Sebastians Banders	Rīgas U-šu Kungfu un austrumcīņu sporta centrs	Latvia	7.733

"Taolu Short weapons Jianshu, Daoshu B (3 set) forms | Female | Juniors 15-17 years"

#	Name	Team	Country	Score
1	Estere Sofija Spūle	Rīgas U-šu Kungfu un austrumcīņu sporta centrs	Latvia	8.633
2	Anastasija Vlasenko	Rīgas U-šu Kungfu un austrumcīņu sporta centrs	Latvia	8.6
3	Mariam Arziani	Georgia Wushu Team	Georgia	8.533
4	Sandra Pļenkova	Team Kung Fu PANSIN	Latvia	8.066

"Taolu Barehand Changquan E (16,20,24) forms | Female | Children 7-8 years"

#	Name	Team	Country	Score
1	Mia Lilientāle	Team Konoha Martial Arts Academy	Latvia	7.233
2	Maija Labetova	Team Konoha Martial Arts Academy	Latvia	7.05
3	Amilija Medneva	Team Konoha Martial Arts Academy	Latvia	6.667
4	Alisa Lapurina	Team Konoha Martial Arts Academy	Latvia	6.433
5	Šarlote Anna Roze	Rīgas U-šu Kungfu un austrumcīņu sporta centrs	Latvia	6.3

"Taolu Barehand Changquan F (1/2 32) forms | Female | Children 7-11 years"

#	Name	Team	Country	Score
1	Olivija Jansone	Rīgas U-šu Kungfu un austrumcīņu sporta centrs	Latvia	6.734
2	Margarita Zaharova	Team Konoha Martial Arts Academy	Latvia	6.65
3	Alisa Puzirjova	Rīgas U-šu Kungfu un austrumcīņu sporta centrs	Latvia	6.167

"Taolu Barehand Changquan E (16,20,24), F (1/2 32) forms | Female | Children 6 years and younger"

#	Name	Team	Country	Score
1	Ksenija Piļinska	Rīgas U-šu Kungfu un austrumcīņu sporta centrs	Latvia	6.317
2	Marija Draganova	Rīgas U-šu Kungfu un austrumcīņu sporta centrs	Latvia	6.3
3	Afina Jelisejeva	Rīgas U-šu Kungfu un austrumcīņu sporta centrs	Latvia	6.167

"Taolu Barehand Changquan E (16,20,24), F (1/2 32) forms | Male | Children 6-8 years"

#	Name	Team	Country	Score
1	Leons Makarovs	Rīgas U-šu Kungfu un austrumcīņu sporta centrs	Latvia	6.333
2	Maksimilians Zvaigzne	Rīgas U-šu Kungfu un austrumcīņu sporta centrs	Latvia	6.167
3	Everts Upens	Rīgas U-šu Kungfu un austrumcīņu sporta centrs	Latvia	6.1

"Taolu Short weapons Taijijian A (Nandu) forms | Male | Cadets 12-14 years"

#	Name	Team	Country	Score
1	Roberts Ritenbergs	Rīgas U-šu Kungfu un austrumcīņu sporta centrs	Latvia	8.6

"Taolu Barehand Changquan D (32) forms | Male | Cadets 12-14 years"

#	Name	Team	Country	Score
1	Edgars Zariņš	Team Konoha Martial Arts Academy	Latvia	7.816
2	Mihails Fiškiss	Team Konoha Martial Arts Academy	Latvia	7.767

"Taolu Barehand Changquan D (32) forms | Male | Children 7-8 years"

#	Name	Team	Country	Score
1	Mihails Varliga	Rīgas U-šu Kungfu un austrumcīņu sporta centrs	Latvia	7.3
2	Dominiks Jelisejevs	Rīgas U-šu Kungfu un austrumcīņu sporta centrs	Latvia	6.933
3	Davids Buckis	Rīgas U-šu Kungfu un austrumcīņu sporta centrs	Latvia	6.883

"Taolu Barehand Changquan F (1/2 32) forms | Male | Children 7-8 years"

#	Name	Team	Country	Score
1	Artemijs Kurakins	Rīgas U-šu Kungfu un austrumcīņu sporta centrs	Latvia	6.333
2	Artemijs Cigankovs	Rīgas U-šu Kungfu un austrumcīņu sporta centrs	Latvia	6.2
3	Artūrs Puzirjovs	Rīgas U-šu Kungfu un austrumcīņu sporta centrs	Latvia	6.2

"Taolu Long weapons Qiangshu, Gunshu B (3 set), C (1,2 set) forms | Male | Juniors 15-17 years"

#	Name	Team	Country	Score
1	Saba Edilashvili	Georgia Wushu Team	Georgia	8.867
2	Nikoloz Nutsbidze	Georgia Wushu Team	Georgia	8.783
3	Filips Sebastians Banders	Rīgas U-šu Kungfu un austrumcīņu sporta centrs	Latvia	8.183

"Taolu Long weapons Qiangshu, Gunshu A (Nandu), B (3 set), C (1,2 set) forms | Female | Cadets, Juniors, Adults"

#	Name	Team	Country	Score
1	Gvantsa Karchava	Georgia Wushu Team	Georgia	8.733
2	Mariam Arziani	Georgia Wushu Team	Georgia	8.633
3	Anastasija Vlasenko	Rīgas U-šu Kungfu un austrumcīņu sporta centrs	Latvia	8.366
4	Sandra Pļenkova	Team Kung Fu PANSIN	Latvia	7.833
5	Anastasija Zorina	Rīgas U-šu Kungfu un austrumcīņu sporta centrs	Latvia	7.3

"Taolu Short weapons Jianshu D (32) forms | Female | Children, cadets 9-14 years"

#	Name	Team	Country	Score
1	Mariam Gvelesiani	Georgia Wushu Team	Georgia	8.034
2	Anna Zablocka	Team Konoha Martial Arts Academy	Latvia	7.517
3	Anna Chitorelidze	Georgia Wushu Team	Georgia	7.5
4	Kira Safronova	Team Kung Fu PANSIN	Latvia	7.033
5	Uljana Lukjanenko	Team Konoha Martial Arts Academy	Latvia	7.017

"Taolu Short weapons Daoshu D (32) forms | Female | Children, Cadets 9-14 years"

#	Name	Team	Country	Score
1	Sati Bagojana	Team Konoha Martial Arts Academy	Latvia	7.067
2	Marija Kustova	Rīgas U-šu Kungfu un austrumcīņu sporta centrs	Latvia	6.733
3	Nikoļa Petrova	Rīgas U-šu Kungfu un austrumcīņu sporta centrs	Latvia	6.433
4	Anna Naudžuna	Rīgas U-šu Kungfu un austrumcīņu sporta centrs	Latvia	6.267

"Taolu Short weapons Daoshu D (32) forms | Male | Cadets 12-14 years"

#	Name	Team	Country	Score
1	Mihails Fiškiss	Team Konoha Martial Arts Academy	Latvia	7.267
2	Edgars Zariņš	Team Konoha Martial Arts Academy	Latvia	6.966
3	Miroslavs Pozņakovs	Rīgas U-šu Kungfu un austrumcīņu sporta centrs	Latvia	

"Taolu Short weapons Jianshu E (16,20,24) forms | Female | Children 9-11 years"

#	Name	Team	Country	Score
1	Ksenija Romaševa	Team Konoha Martial Arts Academy	Latvia	6.6
2	Pojina Romaševa	Team Konoha Martial Arts Academy	Latvia	6.367

"Taolu Short weapons Daoshu D (32) forms | Male | Children 7-11 years"

#	Name	Team	Country	Score
1	Davit Lavrelashvili	Georgia Wushu Team	Georgia	7.6
2	Andrejs Zaborovskis	Rīgas U-šu Kungfu un austrumcīņu sporta centrs	Latvia	7.066
3	Ilja Kiseļovs	Rīgas U-šu Kungfu un austrumcīņu sporta centrs	Latvia	7.033
4	Mihails Varliga	Rīgas U-šu Kungfu un austrumcīņu sporta centrs	Latvia	6.933
5	Jevhenii Sushkevych	Team Konoha Martial Arts Academy	Latvia	6.733
6	Gļebs Seļeckis	Rīgas U-šu Kungfu un austrumcīņu sporta centrs	Latvia	6.667
7	Dominiks Jelisejevs	Rīgas U-šu Kungfu un austrumcīņu sporta centrs	Latvia	6.383
8	Leonids Veselovs	Rīgas U-šu Kungfu un austrumcīņu sporta centrs	Latvia	6.1
9	Davids Buckis	Rīgas U-šu Kungfu un austrumcīņu sporta centrs	Latvia	5.267

"Taolu Short weapons Daoshu E (16,20,24) forms | Male | Children 9-11 years"

#	Name	Team	Country	Score
1	Timurs Krasnovs	Team Konoha Martial Arts Academy	Latvia	6.367

"Taolu Long weapons Gunshu D (32) forms | Male | Children 7-8 years"

#	Name	Team	Country	Score
1	Mihails Varliga	Rīgas U-šu Kungfu un austrumcīņu sporta centrs	Latvia	7.2
2	Dominiks Jelisejevs	Rīgas U-šu Kungfu un austrumcīņu sporta centrs	Latvia	6.534
3	Davids Buckis	Rīgas U-šu Kungfu un austrumcīņu sporta centrs	Latvia	6.3

"Taolu Long weapons Gunshu D (32) forms | Female | Cadets 12-14 years"

#	Name	Team	Country	Score
1	Mariam Gvelesiani	Georgia Wushu Team	Georgia	8.033
2	Veronika Veidere	Team Konoha Martial Arts Academy	Latvia	7.633
3	Marija Kustova	Rīgas U-šu Kungfu un austrumcīņu sporta centrs	Latvia	7.067

"Taolu Long weapons Gunshu D (32) forms | Male | Children 9-11 years"

#	Name	Team	Country	Score
1	Davit Lavrelashvili	Georgia Wushu Team	Georgia	7.733
2	Jevhenii Sushkevych	Team Konoha Martial Arts Academy	Latvia	7.083
3	Leonids Veselovs	Rīgas U-šu Kungfu un austrumcīņu sporta centrs	Latvia	7.067
4	Ilja Kiseļovs	Rīgas U-šu Kungfu un austrumcīņu sporta centrs	Latvia	6.984
5	Mihails Aleksejevs	Team Kung Fu PANSIN	Latvia	6.85
6	Arsenijs Pravdivecis	Rīgas U-šu Kungfu un austrumcīņu sporta centrs	Latvia	6.633
7	Gļebs Seļeckis	Rīgas U-šu Kungfu un austrumcīņu sporta centrs	Latvia	6.45

"Taolu Long weapons Gunshu D (32) forms | Male | Cadets 12-14 years"

#	Name	Team	Country	Score
1	Mihails Fiškiss	Team Konoha Martial Arts Academy	Latvia	7.367
2	Edgars Zariņš	Team Konoha Martial Arts Academy	Latvia	7.3
3	Miroslavs Pozņakovs	Rīgas U-šu Kungfu un austrumcīņu sporta centrs	Latvia	

"Taolu Long weapons Gunshu E (16,20,24), F (1/2 32) forms | Female | Children 7-11 years"

#	Name	Team	Country	Score
1	Ksenija Romaševa	Team Konoha Martial Arts Academy	Latvia	6.8
2	Anna Zablocka	Team Konoha Martial Arts Academy	Latvia	6.716
3	Poļina Romaševa	Team Konoha Martial Arts Academy	Latvia	6.6
4	Alisa Puzirjova	Rīgas U-šu Kungfu un austrumcīņu sporta centrs	Latvia	6.566
5	Margarita Zaharova	Team Konoha Martial Arts Academy	Latvia	6

"Taolu Long weapons Gunshu E (16,20,24), F (1/2 32) | Male | Children 6-11 years"

#	Name	Team	Country	Score
1	Artemijs Kurakins	Rīgas U-šu Kungfu un austrumcīņu sporta centrs	Latvia	6.283
2	Artūrs Puzirjovs	Rīgas U-šu Kungfu un austrumcīņu sporta centrs	Latvia	6.167
3	Artemijs Cigankovs	Rīgas U-šu Kungfu un austrumcīņu sporta centrs	Latvia	6.1
4	Leons Makarovs	Rīgas U-šu Kungfu un austrumcīņu sporta centrs	Latvia	6

"Taolu Long weapons Qiangshu, Gunshu D (32) forms | Female | Children 9-11 years"

#	Name	Team	Country	Score
1	Anna Chitorelidze	Georgia Wushu Team	Georgia	7.933
2	Uljana Lukjanenko	Team Konoha Martial Arts Academy	Latvia	7.567
3	Nikoļa Petrova	Rīgas U-šu Kungfu un austrumcīņu sporta centrs	Latvia	6.9
4	Anna Naudžuna	Rīgas U-šu Kungfu un austrumcīņu sporta centrs	Latvia	6.834

"Bingdao Duilan | | Male"

#	Name	Team	Country	Score
1	Daniils Bille	Rīgas U-šu Kungfu un austrumcīņu sporta centrs	Latvia	8.317
1	Andraniks Halatjans	Rīgas U-šu Kungfu un austrumcīņu sporta centrs	Latvia	8.317
2	Artjoms Goličenkovs	Rīgas U-šu Kungfu un austrumcīņu sporta centrs	Latvia	8.167
2	Mihails Černobiļskis	Rīgas U-šu Kungfu un austrumcīņu sporta centrs	Latvia	8.167
3	Kristaps Žikars	Rīgas U-šu Kungfu un austrumcīņu sporta centrs	Latvia	8.1
3	Žans Freimanis	Rīgas U-šu Kungfu un austrumcīņu sporta centrs	Latvia	8.1
4	Andrejs Čerņavskis	Rīgas U-šu Kungfu un austrumcīņu sporta centrs	Latvia	7.9
4	Jegors Bortņikovs	Rīgas U-šu Kungfu un austrumcīņu sporta centrs	Latvia	7.9

"Bingdao Taolu | | Female | Children, cadets 9-14 years"

#	Name	Team	Country	Score
1	Laura Lipšāne	Rīgas U-šu Kungfu un austrumcīņu sporta centrs	Latvia	8
2	Jelizaveta Geštovta	Rīgas U-šu Kungfu un austrumcīņu sporta centrs	Latvia	7.733
3	Dana Radigina	Rīgas U-šu Kungfu un austrumcīņu sporta centrs	Latvia	7.7

"Bingdao Taolu | Male | Children, Cadets, Juniors"

#	Name	Team	Country	Score
1	Nikita Larionovs	Rīgas U-šu Kungfu un austrumcīņu sporta centrs	Latvia	7.6
2	Semjons Zotovs	Rīgas U-šu Kungfu un austrumcīņu sporta centrs	Latvia	7.6
3	Ritvars Habeks	Rīgas U-šu Kungfu un austrumcīņu sporta centrs	Latvia	7.517
4	Andrejs Čerņavskis	Rīgas U-šu Kungfu un austrumcīņu sporta centrs	Latvia	7.45
5	Jurijs Čubarovs	Rīgas U-šu Kungfu un austrumcīņu sporta centrs	Latvia	7.433
6	Jegors Bortņikovs	Rīgas U-šu Kungfu un austrumcīņu sporta centrs	Latvia	7.317

"Bingdao Taolu | Male | Cadets, Juniors, Adults"

#	Name	Team	Country	Score
1	Daniils Bille	Rīgas U-šu Kungfu un austrumcīņu sporta centrs	Latvia	8.233
2	Andraniks Halatjans	Rīgas U-šu Kungfu un austrumcīņu sporta centrs	Latvia	8.133
3	Žans Freimanis	Rīgas U-šu Kungfu un austrumcīņu sporta centrs	Latvia	8.067
4	Kristaps Žikars	Rīgas U-šu Kungfu un austrumcīņu sporta centrs	Latvia	8.033
5	Artjoms Goličenkovs	Rīgas U-šu Kungfu un austrumcīņu sporta centrs	Latvia	7.967

"Taolu Traditional barehand forms Wudang styles | | Male | Children 9-11 years"

#	Name	Team	Country	Score
1	Leonids Veselovs	Rīgas U-šu Kungfu un austrumcīņu sporta centrs	Latvia	8.2
2	Andrejs Zaborovskis	Rīgas U-šu Kungfu un austrumcīņu sporta centrs	Latvia	8.083
3	Arsenijs Pravdivecs	Rīgas U-šu Kungfu un austrumcīņu sporta centrs	Latvia	7.8
4	Gļebs Seļeckis	Rīgas U-šu Kungfu un austrumcīņu sporta centrs	Latvia	7.767

"Taolu Traditional barehand forms Other styles | | Female | Children 9-11 years"

#	Name	Team	Country	Score
1	Uljana Lukjanenko	Team Konoha Martial Arts Academy	Latvia	8.233

"Taolu Traditional weapons, Short | | Male | Children 7-11 years"

#	Name	Team	Country	Score
1	Mihails Varliga	Rīgas U-šu Kungfu un austrumcīņu sporta centrs	Latvia	8.133

"Taolu Traditional weapons Gunshu | | Male | Children 9-11 years"

#	Name	Team	Country	Score
1	Arsenijs Pravdivecs	Rīgas U-šu Kungfu un austrumcīņu sporta centrs	Latvia	7.9
2	Andrejs Zaborovskis	Rīgas U-šu Kungfu un austrumcīņu sporta centrs	Latvia	7.9

"Taolu Traditional barehand forms Mixed styles | Female | Juniors 15-17 years"

#	Name	Team	Country	Score
1	Estere Sofija Spūle	Rīgas U-šu Kungfu un austrumcīņu sporta centrs	Latvia	8.7
2	Sopiko Apkhazava	Georgia Wushu Team	Georgia	8.617
3	Sofija Hopaniuk	Team Konoha Martial Arts Academy	Latvia	8.2
4	Albina Karolj	Team Konoha Martial Arts Academy	Latvia	8.067

"Taolu Traditional barehand forms Taijiquan | Male | Senior 36 years and older"

#	Name	Team	Country	Score
1	Arvids Vanags	Team Kung Fu PANSIN	Latvia	8.5
2	Andris Miklūns	Rīgas U-šu Kungfu un austrumcīņu sporta centrs	Latvia	8.35
3	Uldis Rubīns	Rīgas U-šu Kungfu un austrumcīņu sporta centrs	Latvia	8.3

"Taolu Traditional barehand forms Mixed styles | Male | Juniors 15-17 years"

#	Name	Team	Country	Score
1	Maksims Jevsejevs	Rīgas U-šu Kungfu un austrumcīņu sporta centrs	Latvia	8.967
2	Giorgi Germanozashvili	Georgia Wushu Team	Georgia	8.883
3	Nikita Matvejevs	Rīgas U-šu Kungfu un austrumcīņu sporta centrs	Latvia	8.767
4	Giorgi Oniani	Georgia Wushu Team	Georgia	8.7
5	Danila Morevs	Team Konoha Martial Arts Academy	Latvia	8.55

"Taolu Traditional barehand forms Taijiquan | Female | Juniors, Adults"

#	Name	Team	Country	Score
1	Nino Chikhladze	Georgia Wushu Team	Georgia	9
2	Niia Chkhaidze	Georgia Wushu Team	Georgia	8.567
3	Jekaterina Safronova	Team Kung Fu PANSIN	Latvia	8.3

"Taolu Traditional barehand forms Mixed styles | Female | Cadets 12-14 years"

#	Name	Team	Country	Score
1	Zlata Tvorogova	Team Konoha Martial Arts Academy	Latvia	8.483
2	Miraslava Rinkeviča	Team Konoha Martial Arts Academy	Latvia	8.383
3	Arina Plotnikova	Team Konoha Martial Arts Academy	Latvia	8.333
4	Marija Kustova	Rīgas U-šu Kungfu un austrumcīņu sporta centrs	Latvia	8.033

"Taolu Traditional barehand forms Wudang styles | Male | Cadets 12-14 years"

#	Name	Team	Country	Score
1	Iļja Mihailovs	Rīgas U-šu Kungfu un austrumcīņu sporta centrs	Latvia	8.3
2	Edgars Zariņš	Team Konoha Martial Arts Academy	Latvia	8.233
3	Miroslavs Pozņakovs	Rīgas U-šu Kungfu un austrumcīņu sporta centrs	Latvia	

"Taolu Traditional barehand forms Taijiquan | Male | Cadets, Juniors, Adults"

#	Name	Team	Country	Score
1	Mate Kortkhonjia	Georgia Wushu Team	Georgia	9
2	Ruvims Blats	Rīgas U-šu Kungfu un austrumcīņu sporta centrs	Latvia	8.817
3	Nikita Matvejevs	Rīgas U-šu Kungfu un austrumcīņu sporta centrs	Latvia	8.667
4	Roberts Ritenbergs	Rīgas U-šu Kungfu un austrumcīņu sporta centrs	Latvia	8.5

"Taolu Traditional weapons Short | Female | Cadets 12-14 years"

#	Name	Team	Country	Score
1	Zlata Tvorogova	Team Konoha Martial Arts Academy	Latvia	8.617
2	Miraslava Rinkeviča	Team Konoha Martial Arts Academy	Latvia	8.533
3	Poļina Kovtaņuka	Team Konoha Martial Arts Academy	Latvia	8.483

"Taolu Traditional barehand forms Taijiquan | Female | Senior 36 years and older"

#	Name	Team	Country	Score
1	Maka Gabeskiria	Georgia Wushu Team	Georgia	8.967
2	Laura Buraka	Team Kung Fu PANSIN	Latvia	8.733
3	Jekaterina Varliga	Rīgas U-šu Kungfu un austrumcīņu sporta centrs	Latvia	8.467
4	Vitalija Drozdova	Rīgas U-šu Kungfu un austrumcīņu sporta centrs	Latvia	8.433
5	Olga Selecka	Rīgas U-šu Kungfu un austrumcīņu sporta centrs	Latvia	8.4
6	Olga Kirpičņikova	Rīgas U-šu Kungfu un austrumcīņu sporta centrs	Latvia	8.367

"Taolu Traditional weapons, Short | Male | Cadets, Juniors 12-17 years"

#	Name	Team	Country	Score
1	Nikita Matvejevs	Rīgas U-šu Kungfu un austrumcīņu sporta centrs	Latvia	8.617
2	Giorgi Germanozashvili	Georgia Wushu Team	Georgia	8.583
3	Iļja Mihailovs	Rīgas U-šu Kungfu un austrumcīņu sporta centrs	Latvia	8.233
4	Nikita Matvejevs	Rīgas U-šu Kungfu un austrumcīņu sporta centrs	Latvia	

"Taolu Traditional weapons Short and Double | Female | Juniors, Adults"

#	Name	Team	Country	Score
1	Estere Sofija Spūle	Rīgas U-šu Kungfu un austrumcīņu sporta centrs	Latvia	8.867
2	Sopiko Apkhazava	Georgia Wushu Team	Georgia	8.833
3	Anastasiya Kokina	Rīgas U-šu Kungfu un austrumcīņu sporta centrs	Latvia	8.767
4	Sandra Pļenkova	Team Kung Fu PANSIN	Latvia	8.667
5	Sofija Hopaniuk	Team Konoha Martial Arts Academy	Latvia	8.65

"Taolu Traditional Long weapons | Male | Cadets, Juniors 12-17 years"

#	Name	Team	Country	Score
1	Giorgi Oniani	Georgia Wushu Team	Georgia	8.817
2	Roberts Ritenbergs	Rīgas U-šu Kungfu un austrumcīņu sporta centrs	Latvia	8.667
3	Nykyta Kokins	Rīgas U-šu Kungfu un austrumcīņu sporta centrs	Latvia	8.633
4	Nikita Matvejevs	Rīgas U-šu Kungfu un austrumcīņu sporta centrs	Latvia	8.5
5	Iļja Mihailovs	Rīgas U-šu Kungfu un austrumcīņu sporta centrs	Latvia	8.45
6	Miroslavs Pozņakovs	Rīgas U-šu Kungfu un austrumcīņu sporta centrs	Latvia	

"Taolu Traditional weapons Gunshu | Female | Cadets, Adults"

#	Name	Team	Country	Score
1	Jekaterina Safronova	Team Kung Fu PANSIN	Latvia	8.683
2	Poļina Kovtaņuka	Team Konoha Martial Arts Academy	Latvia	8.6
3	Marija Kustova	Rīgas U-šu Kungfu un austrumcīņu sporta centrs	Latvia	8.433

"Taolu Traditional weapons Taiji | Male | Adults 18-35 years"

#	Name	Team	Country	Score
1	Mate Kortkhonjia	Georgia Wushu Team	Georgia	8.933
2	Ruvims Blats	Rīgas U-šu Kungfu un austrumcīņu sporta centrs	Latvia	8.883

"Taolu Traditional weapons Taiji | Male | Senior 36 years and older"

#	Name	Team	Country	Score
1	Arvids Vanags	Team Kung Fu PANSIN	Latvia	8.733
2	Uldis Rubīns	Rīgas U-šu Kungfu un austrumcīņu sporta centrs	Latvia	8.483
3	Andris Miklūns	Rīgas U-šu Kungfu un austrumcīņu sporta centrs	Latvia	8.45

"Taolu Traditional weapons Taiji | Female | Juniors, Adults, Seniors"

#	Name	Team	Country	Score
1	Nino Chikhladze	Georgia Wushu Team	Georgia	9
2	Maka Gabeskiria	Georgia Wushu Team	Georgia	8.85
3	Niia Chkhaidze	Georgia Wushu Team	Georgia	8.667
4	Laura Buraka	Team Kung Fu PANSIN	Latvia	8.633
5	Jekaterina Varliga	Rīgas U-šu Kungfu un austrumcīņu sporta centrs	Latvia	8.5
6	Vitalija Drozdova	Rīgas U-šu Kungfu un austrumcīņu sporta centrs	Latvia	8.4
7	Olga Kirpičņikova	Rīgas U-šu Kungfu un austrumcīņu sporta centrs	Latvia	8.333
8	Olga Selecka	Rīgas U-šu Kungfu un austrumcīņu sporta centrs	Latvia	8.117

Children/ Male/ 10-12 years/ Sanda/ -52kg

- 1 Georgijs Panurskis
- 2 Ilja Kurakins

I	Georgijs Panurskis
II	Ilja Kurakins

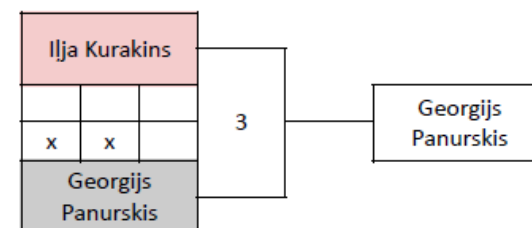
Fināls

Children/ Male/ 11-12 years/ Sanda - 52kg

- 1 Aleksejs Zvaigzne
- 2 Dāvids Topurovs

I	Aleksejs Zvaigzne
II	Dāvids Topurovs

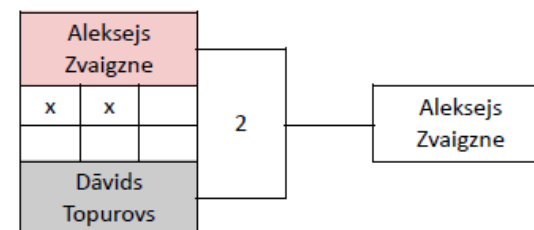
Fināls

Juniors/ Female/ 14-16 years/ Sanda -60kg

- 1 Kira Kuročkina
- 2 Miraslava Rinkeviča

I	Miraslava Rinkeviča
II	Kira Kuročkina

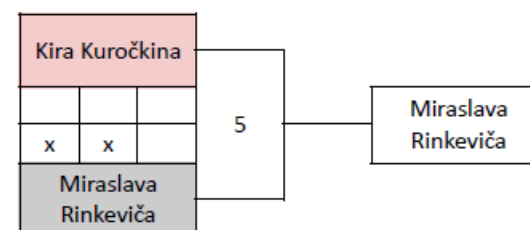
Fināls

Cadets/ Male/ 12-14 years/ Sanda -85kg

- 1 Jegors Semjonovs
- 2 Edmunds Pokrovskis
- 3 Roberts Prančs

I	Edmunds Pokrovskis
II	Roberts Prančs
III	Jegors Semjonovs

Fināls

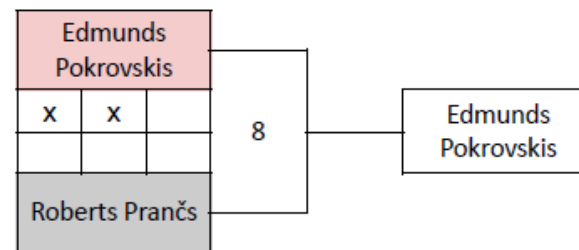
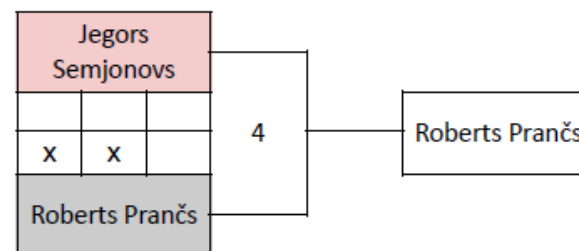
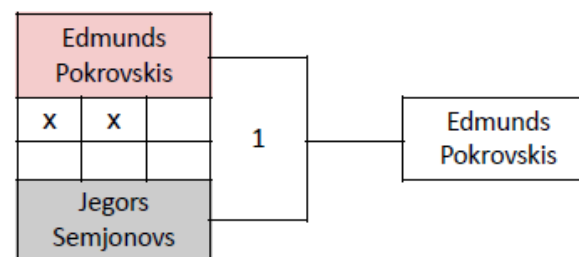

Juniors/ Male/ 14-15 years/ Sanda -75kg

- 1 Raivo Aleksis Jērums
- 2 Mihails Paeglis

I	Raivo Aleksis Jērums
II	Mihails Paeglis

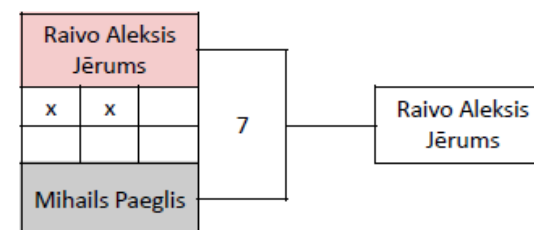
Fināls

Juniors/ Male/ 14-15 years/ Sanda -65kg

- 1 Demians Dmitrijevs
- 2 Stefans Marcinkevičs

I	Demians Dmitrijevs
II	Stefans Marcinkevičs

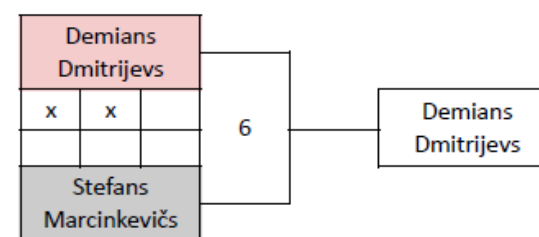
Fināls

Bingdao/ Male/ Children 7-9 years

- 1 Rihards Valters
- 2 Deniss Meļņikovs
- 3 Kārlis Dzintars

I	Deniss Meļņikovs
II	Rihards Valters
III	Kārlis Dzintars

Fināls

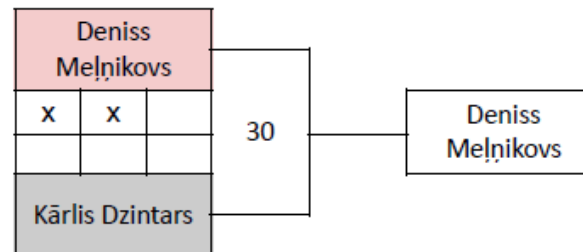
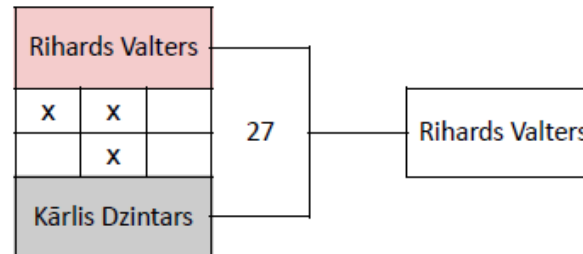
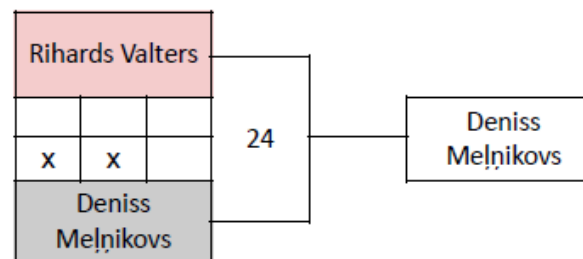

Bingdao/ Male/ Children 10 - 11 years

- 1 Timurs Krasnovs
- 2 Andrejs Čerņavskis
- 3 Vladislavs Belskis
- 4 Antons Moškins
- 5 Ilja Kurakins
- 6 Platons Bojarkins
- 7 Jegors Bortnikovs

I	Ilja Kurakins
II	Vladislavs Belskis
III	Platons Bojarkins

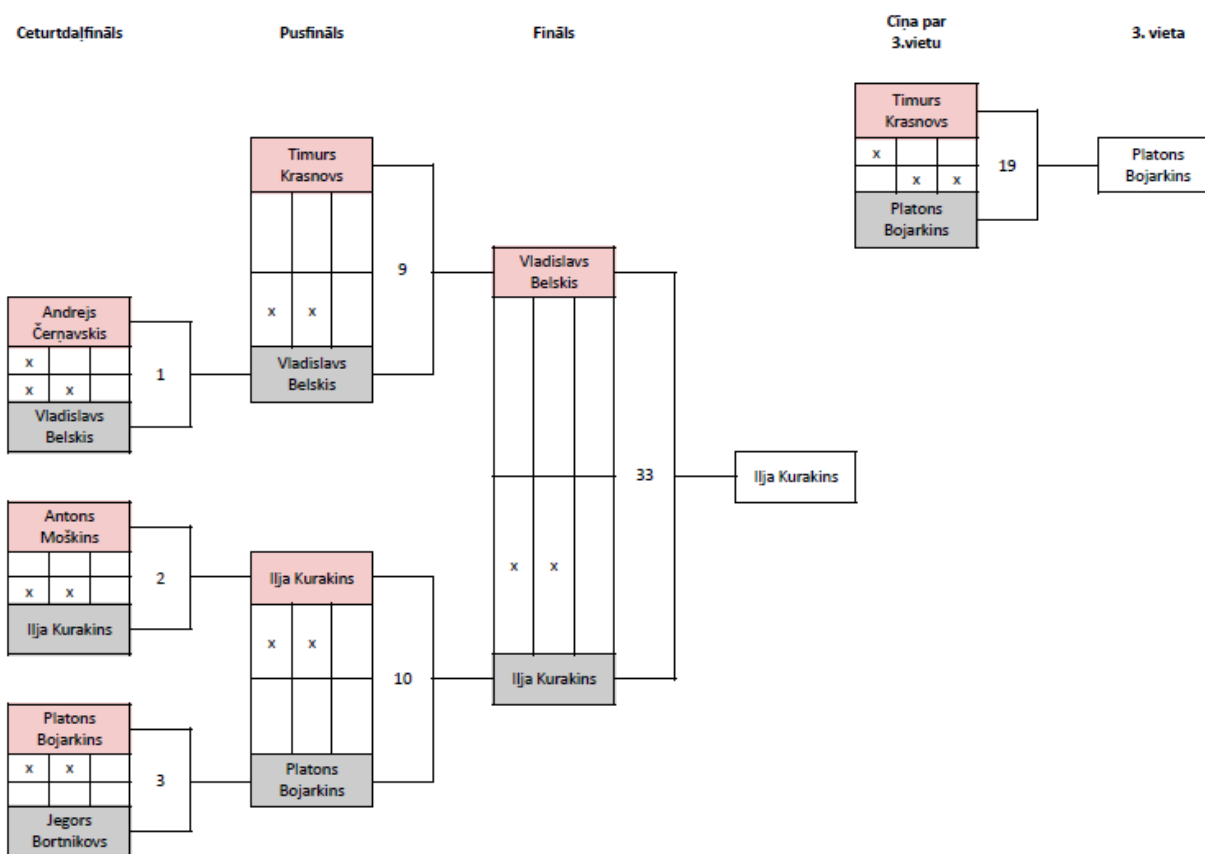

Bingdao/ Male/ Cadets 12-16 years

- 1 Ritvars Habeks
- 2 Mihails Černobiļskis
- 3 Nikita Larionovs
- 4 Semjons Zotovs

I	Mihails Černobiļskis
II	Nikita Larionovs
III	Ritvars Habeks

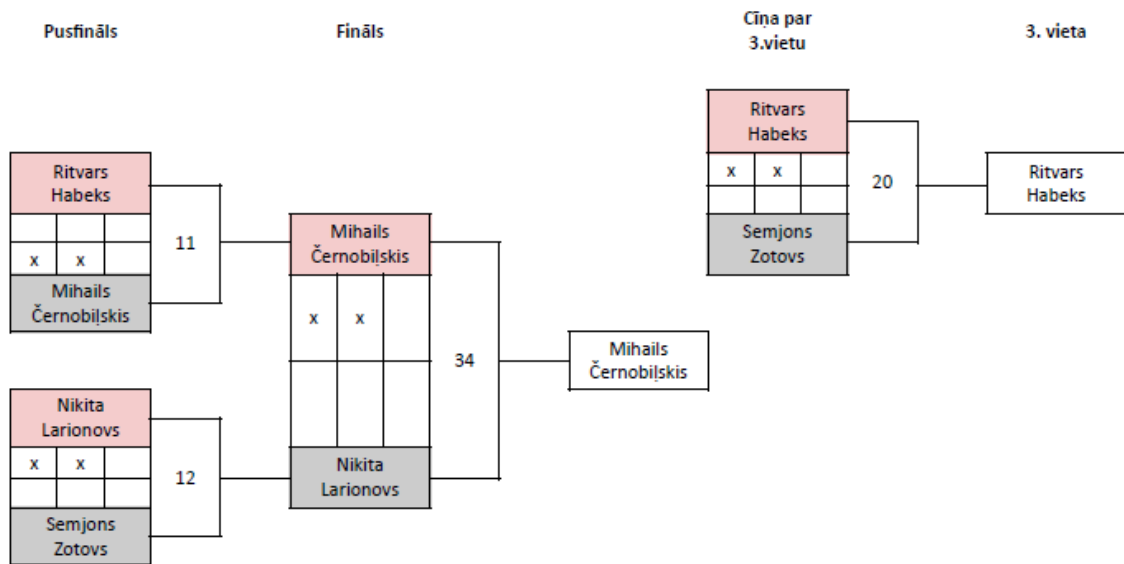

Bingdao/ Male/ Cadets 13 years

- 1 Ilya Poljanski
- 2 Mihails Paeglis
- 3 Jurijs Čubarovs
- 4 Žans Freimanis
- 5 Artjoms Goličenkovs
- 6 Kristaps Žikars

I	Mihails Paeglis
II	Artjoms Goličenkovs
III	Ilya Poljanski

Ceturtdaļfināls

Pusfināls

Fināls

Ģīņa par 3.vietu

3. vieta

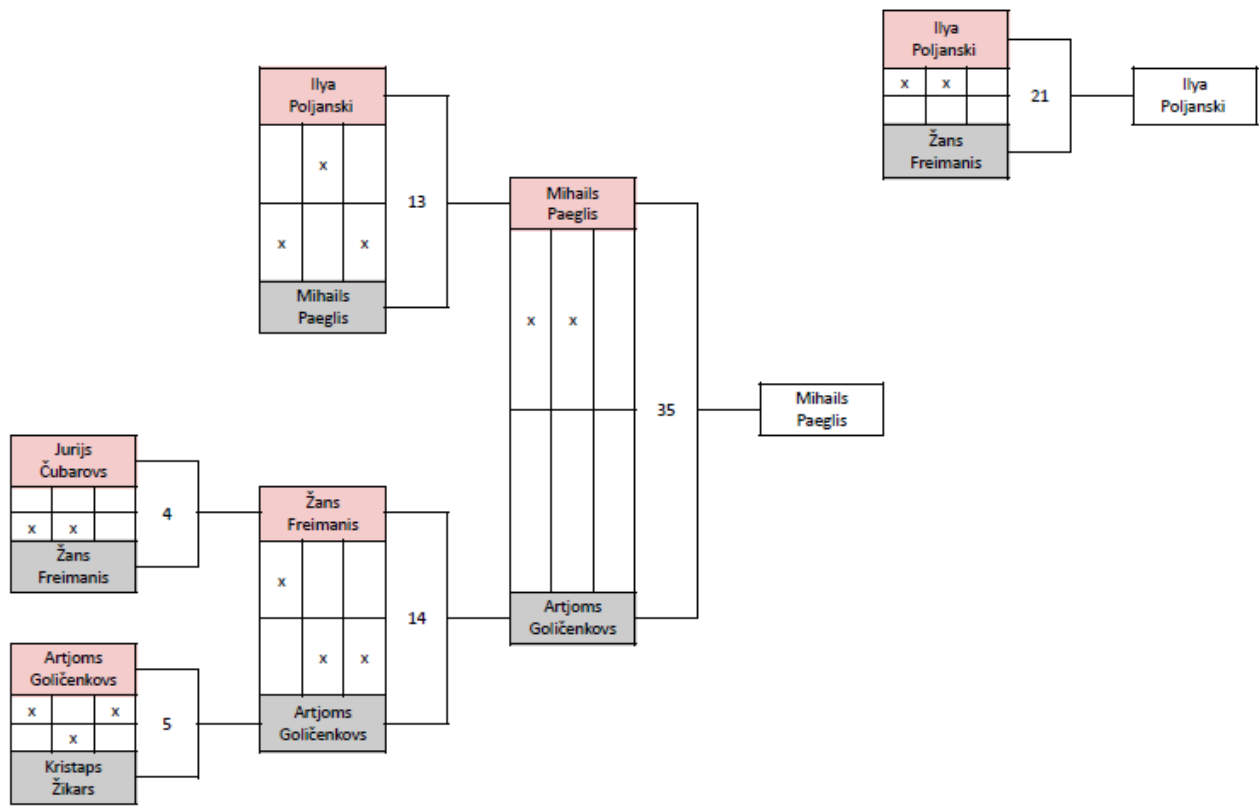

Bingdao/ Male/ Juniors 15-17 years

- 1 Daniils Bille
- 2 Arseni Vtorov
- 3 Artjom Kononenko
- 4 Egon Kai Orlov
- 5 Nikita Datskovskiy
- 6 Alexander Kisseljov

I	Arseni Vtorov
II	Nikita Datskovskiy
III	Daniils Bille

Ceturtdaļfināls

Pusfināls

Fināls

Cīņa par 3.vietu

3. vieta

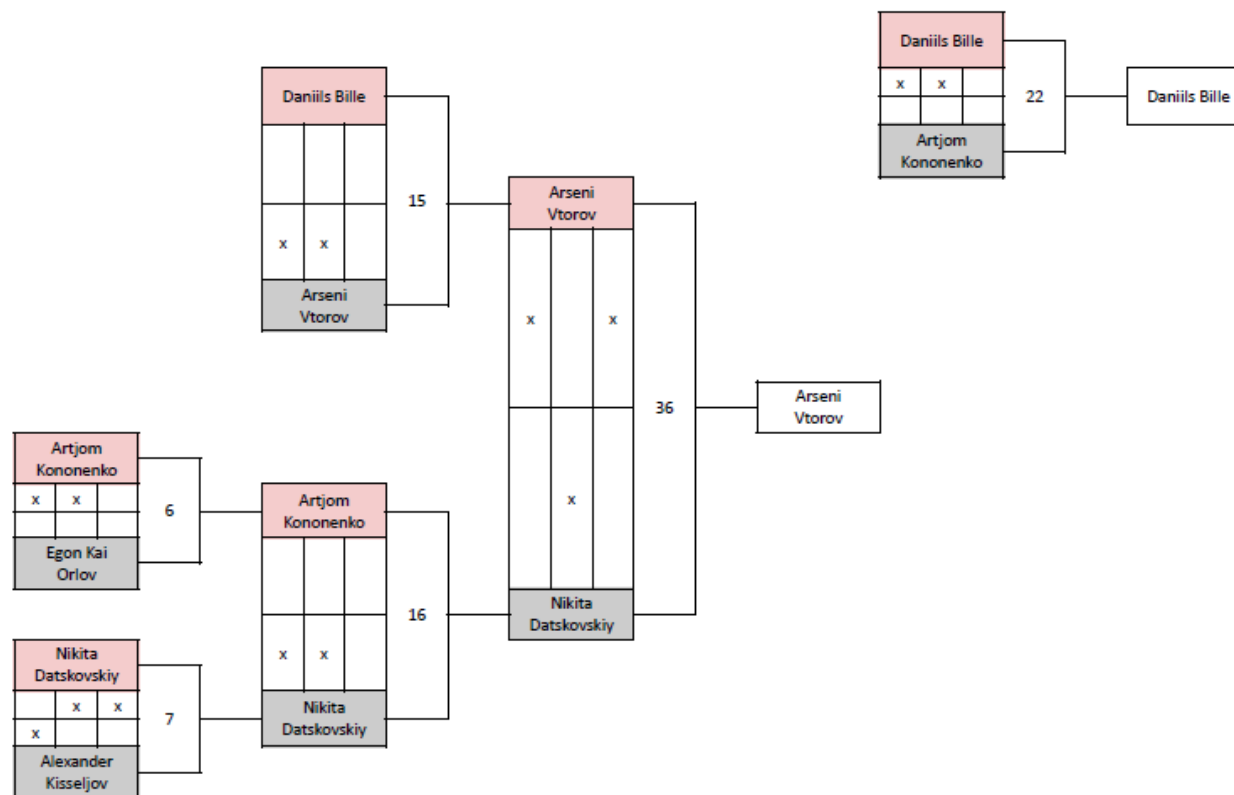

Bingdao/ Male/ Adults 18+ years

- 1 Andranik Halatjans
- 2 Dmitri Tšelošev
- 3 Andrei Kisseljov

I	Andrei Kisseljov
II	Dmitri Tšelošev
III	Andranik Halatjans

Fināls

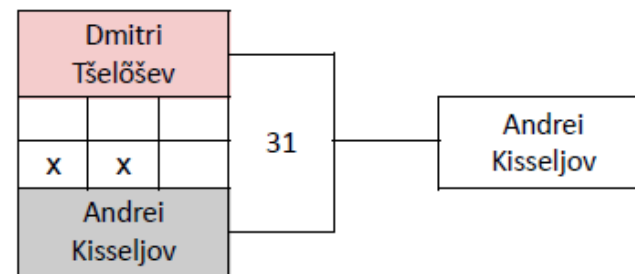
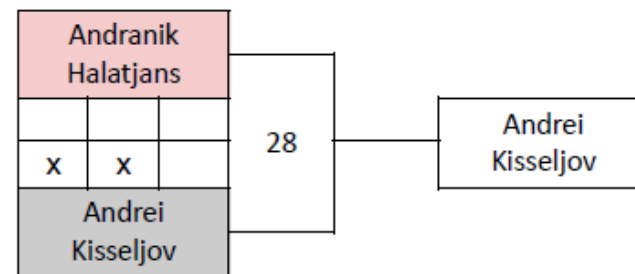
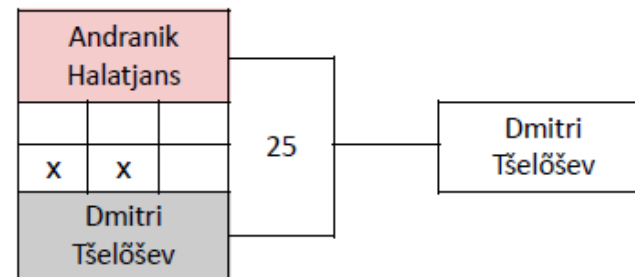

Bingdao/ Female/ Children 9-11 years

- 1 Karolina Kļecka
- 2 Sati Bagojana
- 3 Anna Naudžuna
- 4 Oleksandra Zhamlikhanova
- 5 Dana Radigina

I	Sati Bagojana
II	Dana Radigina
III	Anna Naudžuna

Ceturtdaļfināls

Pusfināls

Fināls

Cīņa par 3.vietu

3. vieta

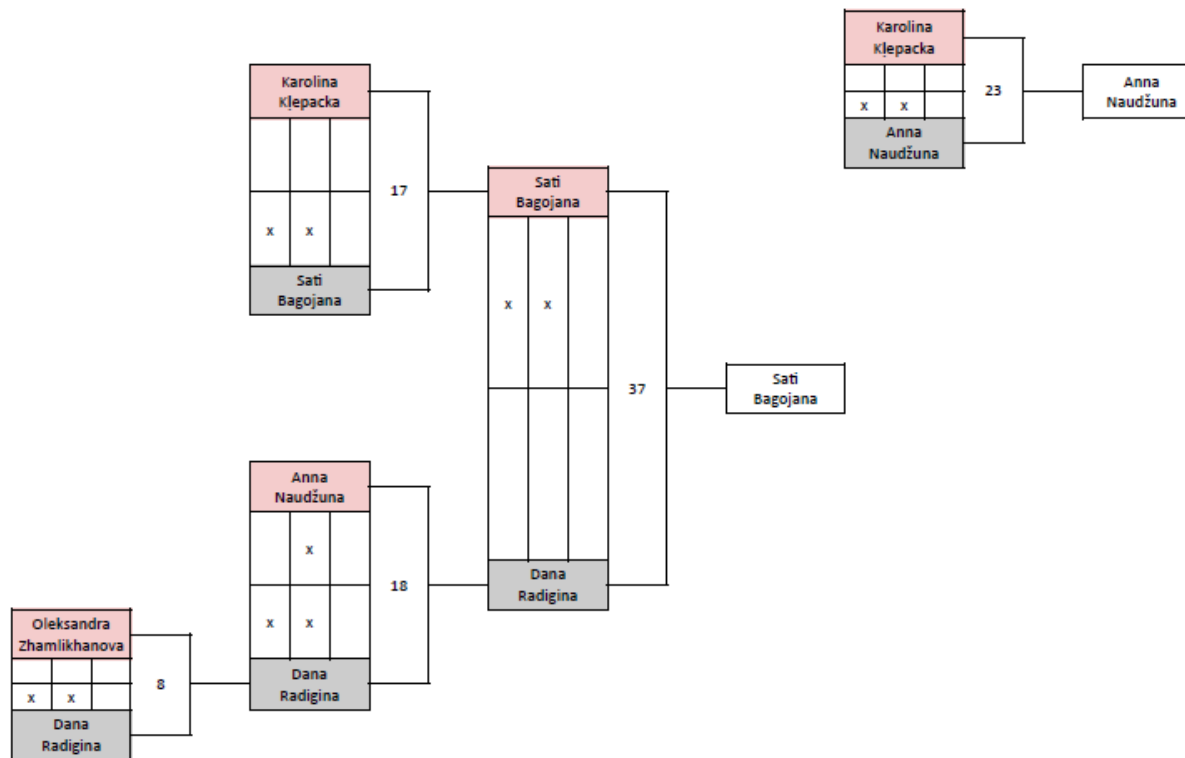

Bingdao/ Female/ Cadets 12-14 years

- 1 Amelia Matrunjonok
- 2 Laura Lipšāne
- 3 Jelizaveta Geštovta

I	Amelia Matrunjonok
II	Jelizaveta Geštovta
III	Laura Lipšāne

Fināls